

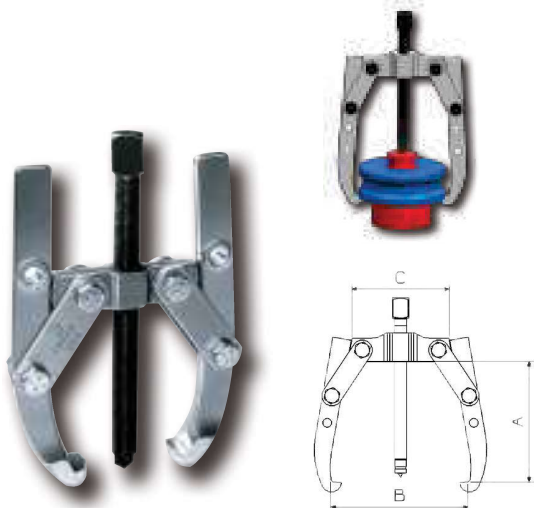







**Extractor 2 patas oscilantes / 2 oscillating jaws pullers** **Serie 1300**

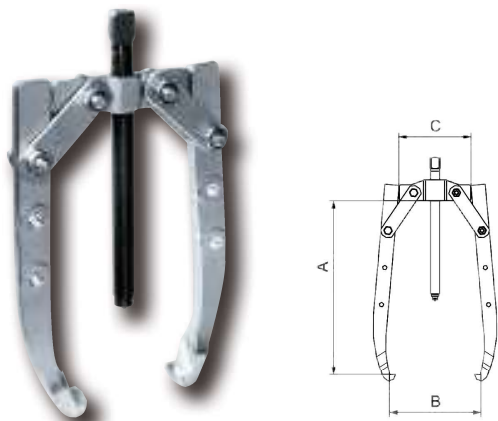

Ref.	€/u.	A	B	C			
1300	33,20	55	70	37	0,2	130003	130005
1301	42,80	85	100	70	0,4	130103	130105
1304	64,00	135	150	80	1,2	130403	130405
1307	94,70	180	200	113	2,3	130703	130705
1308	103,40	180	250	160	2,7	130703	130705
1310	186,70	300	310	161	5,5	131031	131005
1317	348,60	370	425	280	11,5	131731	131705
1330	748,10	460	520	325	25,5	133031	133005
1350	1.202,00	750	800	402	49,0	135032	135005

**Extractor 2 patas largas oscilantes / 2 oscillating long jaws pullers** **Serie 1300L**







Ref.	€/u.	A	B	C			
1300L	37,00	70	90	37	0,2	130003	130006
1301L	46,40	105	110	70	0,5	130103	130106
1304L	69,40	185	175	80	1,4	130403	130406
1307L	102,50	225	240	113	2,5	130703	130706
1308L	111,20	225	290	160	2,9	130703	130706
1310L	194,50	400	350	161	6,0	131031	131006
1317L	379,80	480	480	280	13,0	131731	131706
1330L	788,90	590	650	325	30,0	133031	133006
1350L	1.316,00	900	980	402	55,5	135032	135206

L = Pata serie larga, mayor capacidad.

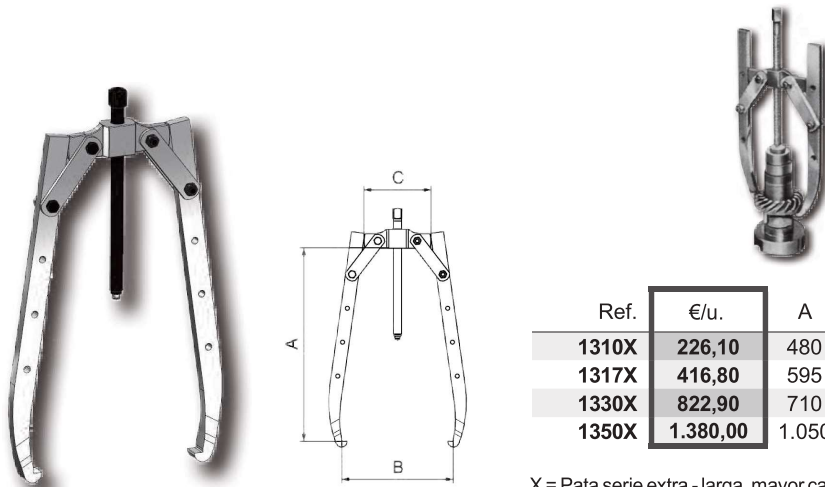
L = Long jaw, bigger capacity.

**Extractor 2 patas extra largas oscilantes / 2 oscillating extra long jaws puller** **Serie 1300X**



Ref.	€/u.	A	B	C			
1310X	226,10	480	405	161	7,6	131031	131016
1317X	416,80	595	540	280	15,0	131731	131716
1330X	822,90	710	720	325	34,5	133031	133016
1350X	1.380,00	1.050	1.080	402	62,3	135032	135216

X = Pata serie extra - larga, mayor capacidad.



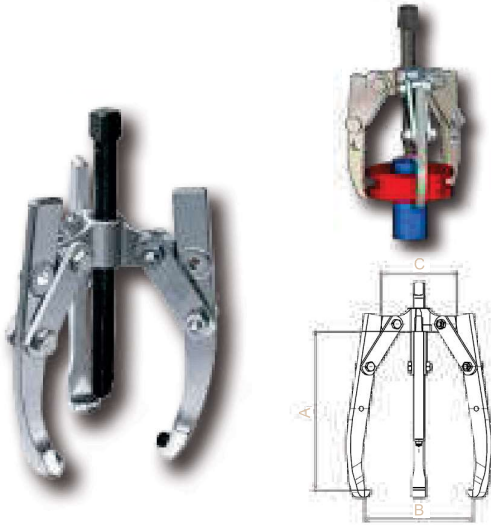

X = Extra - long jaw, bigger capacity.

**Extractor 2/3 patas oscilantes / 2/3 oscillating jaws pullers**

**Serie 1300T**



Combina con  
2/3 patas



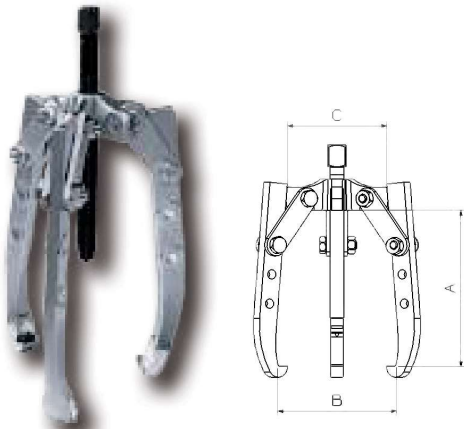

Ref.	€/u.	A	B	C				
1300T	47,10	55	70	37	-	0,3	130003	130005
1301T	63,20	85	100	80	✓	0,7	130103	130105
1304T	94,60	135	150	104	✓	1,8	130403	130405
1307T	126,00	180	200	108	✓	3,3	130703	130705
1308T	142,40	180	250	160	✓	3,7	130703	130705
1310T	298,80	300	310	161	✓	7,5	131031	131005
1317T	514,90	370	425	280	-	17,0	131731	131705
1330T	965,90	460	520	325	-	33,5	133031	133005
1350T	1.649,00	750	800	402	-	65,0	135032	135005

**Extractor 2/3 patas largas oscilantes  
2/3 oscillating long jaws pullers**

**Serie 1300LT**



Combina con  
2/3 patas

Ref.	€/u.	A	B	C				
1300LT	52,80	70	90	37	-	0,3	130003	130006
1301LT	68,60	105	110	80	✓	0,7	130103	130106
1304LT	102,70	185	175	104	✓	2,1	130403	130406
1307LT	137,70	225	240	108	✓	3,5	130703	130706
1308LT	154,10	225	290	160	✓	3,9	130703	130706
1310LT	310,50	400	350	161	✓	8,5	131031	131006
1317LT	561,70	480	480	280	-	18,5	131731	131706
1330LT	1.027,10	590	650	325	-	39,0	133031	133006
1350LT	1.820,00	900	980	402	-	75,0	135032	135206

L = Pata serie larga, mayor capacidad.



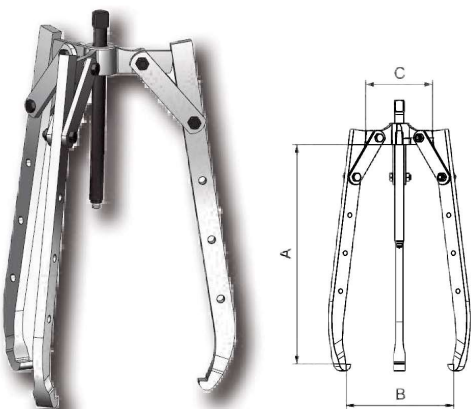

L = Long jaw, bigger capacity.

**Extractor 2/3 patas extra largas oscilantes  
2/3 oscillating extra long jaws puller**

**Serie 1300XT**



Combina con  
2/3 patas

Ref.	€/u.	A	B	C				
1310XT	357,90	480	405	161	✓	10,9	131031	131016
1317XT	618,00	595	540	280	-	20,5	131731	131716
1330XT	1.078,10	710	720	325	-	45,5	133031	133016
1350XT	1.916,00	1.050	1.080	402	-	85,5	135032	135216

X = Pata serie extra - larga, mayor capacidad.

X = Extra - long jaw, bigger capacity.